



KAYRA ÇOK AMAÇLI DOLAP

İLETİŞİM : 0850 888 38 00

ar de no

Ax12
Bx12

A 001 ALYAN VİDA 48 AD 	B 002 ALYAN 1 AD 	C 003 CİVİ 110 AD 	D 004 DÜZ MENTESE 5 AD 	E 005 3.5X1.8 VİDA 32 AD 	F 006 3.5X1.3 VİDA 6 AD
G 007 4X40 KİLİP VİDA 6 AD 	H 008 ALYAN 1 AD 	I 009 56 LİK KİLİP 5 AD 	O BEYAZ 	J 010 RAY 6 AD 	P 011 RAF PİMİ 16 AD
S BEYAZ KAPANI 12 AD 	012 4X25 KUL VİDA 4 AD 				

Ex16

Fx4

2

Cx20

3

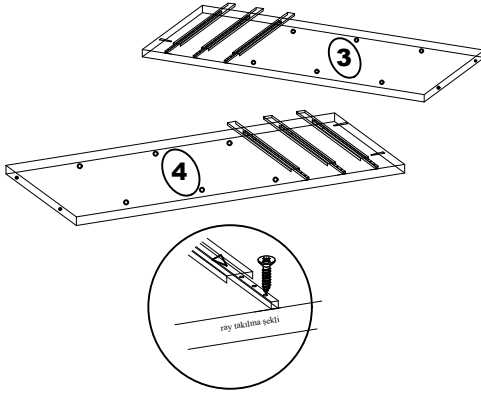

3 VE 4 NUMARALI PARÇALARA ÇEKMECERAYLARINI TAKIN

GENEL GÖRÜNÜM VE PARÇA NUMARALARI

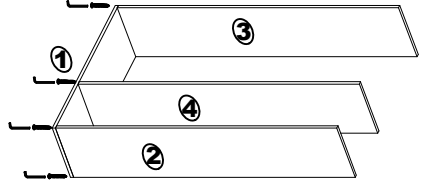
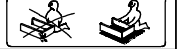

PARÇARI YARDIM ALARAK BANTLI YÜZEYLER AŞAĞI GELECEK ŞEKİLDE YATIRIN VE M6 ALYAN VİDALARINI BELİRTİLEN ŞEKİLDE ALYAN ANAHTARI İLE SIKIN.

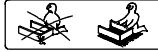

4

5

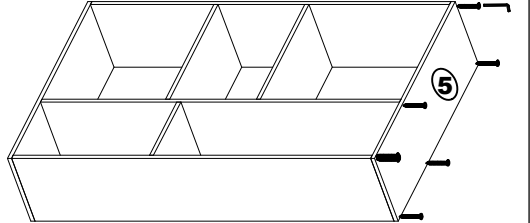
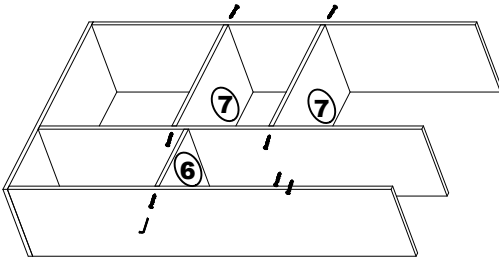

Ayakları monte edip iki kişi ile dolabı kaldırın.

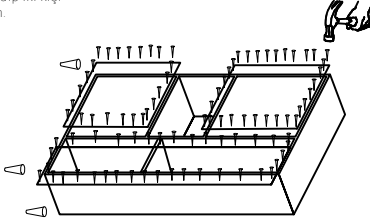

Çekiç yardımı ile arka katları çiviyile sabitleyin.

Ax12
Bx12

Çekmeceleri şekildedeki gibi birleştirin, ters çevirip arkasını küçük çiviler ile çakın.

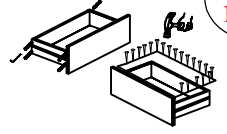

1

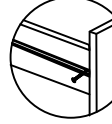

Çekmece yanındaki kanalları şekildedeki gibi raylara geçirerek 3,5x13 vida ile sabitleyin.



Ex16
Fx4

2

Cx20

3

Raf pimlerini şekilde görülen şekilde deliklere yerleştirip numaralı rafları yerleştirin.

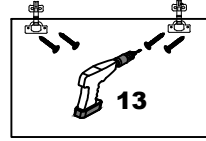
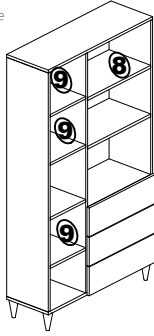
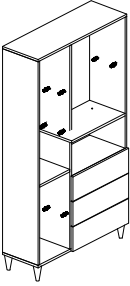

Kapaklara menteşeleri 3,5x18 vidalar ile sabitleyin ve yerlerine takın.

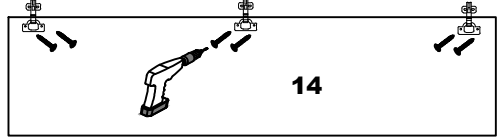

4

5

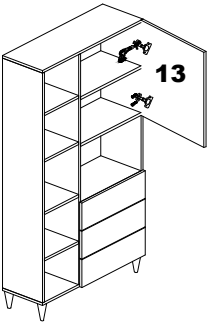

13

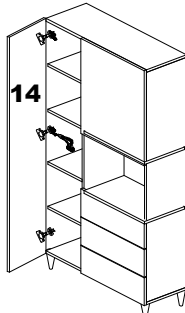

14

Menteşeleri görseldeki gibi işaretli bölgelere 3,5x18 vida ile yardım olarak sabitleyin.

12- Kulpları takın.

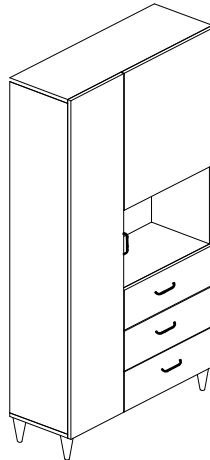

İLETİŞİM 0850 888 38 00

BİZİ TERCİH ETTİĞİNİZ İÇİN TEŞEKKÜR EDERİZ